

MAS .223

The MAS .223 semi-automatic rifle

manufactured by the

“Manufacture Nationale d’Armes

de Saint - Etienne.”

TABLE OF CONTENTS

	Page
Chapter I — General information.	4
Chapter II — Description and operation	7
Chapter III — Use in normal conditions.	15
Chapter IV — Use in special conditions.	19
Chapter V — Jamming and trouble	20
Chapter VI — Maintenance	22
Chapter VII — Parts list.	28
Chapter VIII — Table of compined unit components	28

INTRODUCTION

The MAS . 223 semi-automatic rifle has been studied by the Manufacture Nationale d'Armes de Saint-Etienne.

This rifle, derived from the FA-MAS 5.56 - F1, has been specially designed for civil uses as a sporter carbine which has the following standpoints :

- ergonomics, with due consideration being given to the permanent requirements of the user : dimensions, weight, transfer, ease of use and maintenance, etc.,
 - reliability and operating safety under the most difficult conditions of use,
 - efficiency of its multiple functions : precision firing of single shots, excellent stability and high power,
 - general quality of manufacture, with systematic monitoring of raw materials, the fabrication processes and firing performance of the rifle.
- Apart from the additional equipment supplied : bipod, bayonet attachment, cleaning accessories, etc...

1 — GENERAL INFORMATION

1-1 — Presentation of the equipment

1-1-1 — Function

The MAS calibre . 223 is a semi-automatic weapon designed for :

- . 223 Remington firing with single shot fire.

1-2 — General description of the weapon

The operating mechanism is an inertia amplifying mechanism.

Empty cases are ejected to the right or to the left, according to the conformation of the firer.

The line of sight, with single backsight, allows aiming adjustment for elevation and direction — there is also a retractable slide fitted with luminescent spot night firing.

The entirely armoured plastic fittings ensure :

- Protection of the vital parts of the weapon including the sighting parts.
- Effective grasp for firing and carrying the weapon.
- Protection of the user against firing heat.



1-3 — Static features

— Length :

Overall length without bayonet	757 mm
Barrel and branch length	488 mm
Length of line of sight	330 mm

— Weight :

of the weapon without magazine or sling or bipod	3.610 kg
of the empty magazine	0.150 kg
of the magazine fitted with 25 cartridges	0.450 kg
of bayonet and sheath	0.480 kg
of sling	0.150 kg
of bipod	0.170 kg

— Barrel rifling :

Number	3
Screw	Right-hand
Pitch	12 ins, i.e., 305 mm
optional pitch	9 ins, i.e., 228 mm

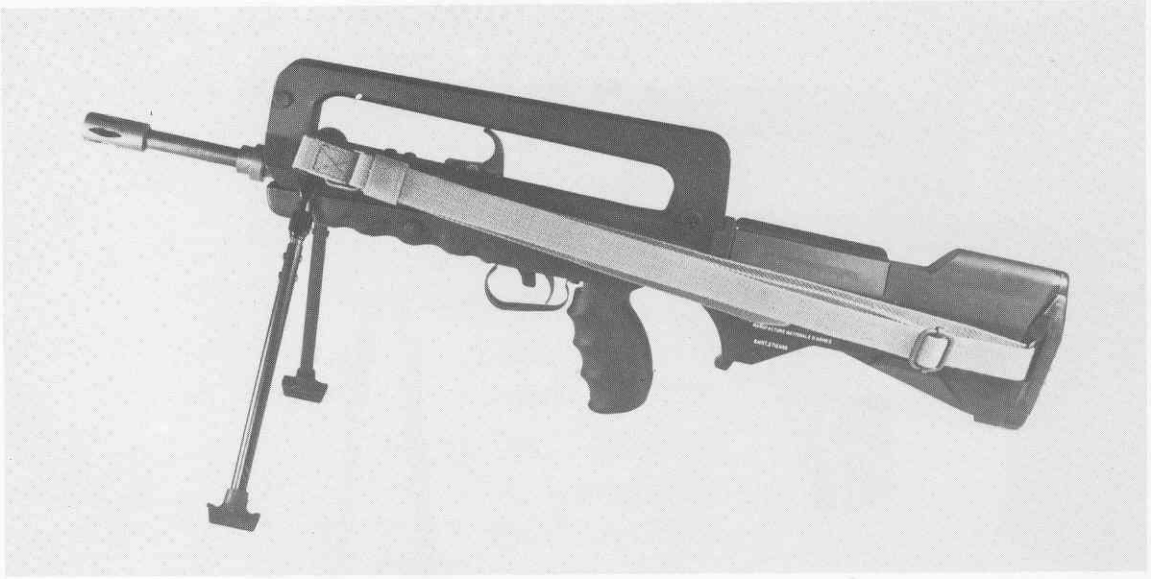

1-4 – Performance

Muzzle velocity of the ammunition V_0 : 960 m/s

H + L at 200 metres < 400 mm on a series of 10 cartridges.

H + L at 300 metres < 600 mm on a series of 10 cartridges

1-5 – Operating limits

1-5-1 – Temperatures

1-5-1-1 – Extreme storage temperature

– 54°C

+ 71°C

1-5-1-2 – Extreme operating temperatures

– For bullet firing

– 40°C

+ 51.5°C

1-5-2 – Barrel wear

Barrel resistance : 10 000 shots

1-5-3 – Range limits

– Bullet firing

Single backsight from 0 to 300 metres.

1-6 – Safety rules specific to the weapon described

1-6-1 – During transport

If the weapon is loaded, ensure that the safety catch is effectively in the "safety" position.



1-6-2 – Before firing

Ensure :

- that the firing pin and the cocking lever are in proper order,
- that the barrel is perfectly clean ; in particular, under operating conditions which may involve a risk of filling with water, take the precaution of opening the breech and tilting the weapon downwards to release any water,

that the cheek-rest is on the opposite side to ejection.

1-6-3 – During firing

- Do not put the hand between the protective handle and the cocking lever slot.

1-6-4 – After firing

- When the magazine still contains ammunition : put the safety catch back to the safety position.
- When the magazine is empty : make sure that the chamber is empty of any ammunition.

1-7 – Optional calibre

The barrel may be chambered for:

- . 222 Remington and . 222 Remington Magnum

2 — DESCRIPTION AND OPERATION

2-1 — DESCRIPTION

The rifle is made up of 9 main parts :

- 1 — The "rifle body", itself made up of the following components :
-Barrel -Breech casing -Cocking mechanism -Stock -Tube sub-assembly.
- 2 — The mobile assembly
- 3 — The mechanism unit
- 4 — The stock fitted with the cheek rest
- 5 — The protective handle
- 6 — The magazine
- 7 — The sling
- 8 — The two branches of the bipod
- 9 — The bayonet

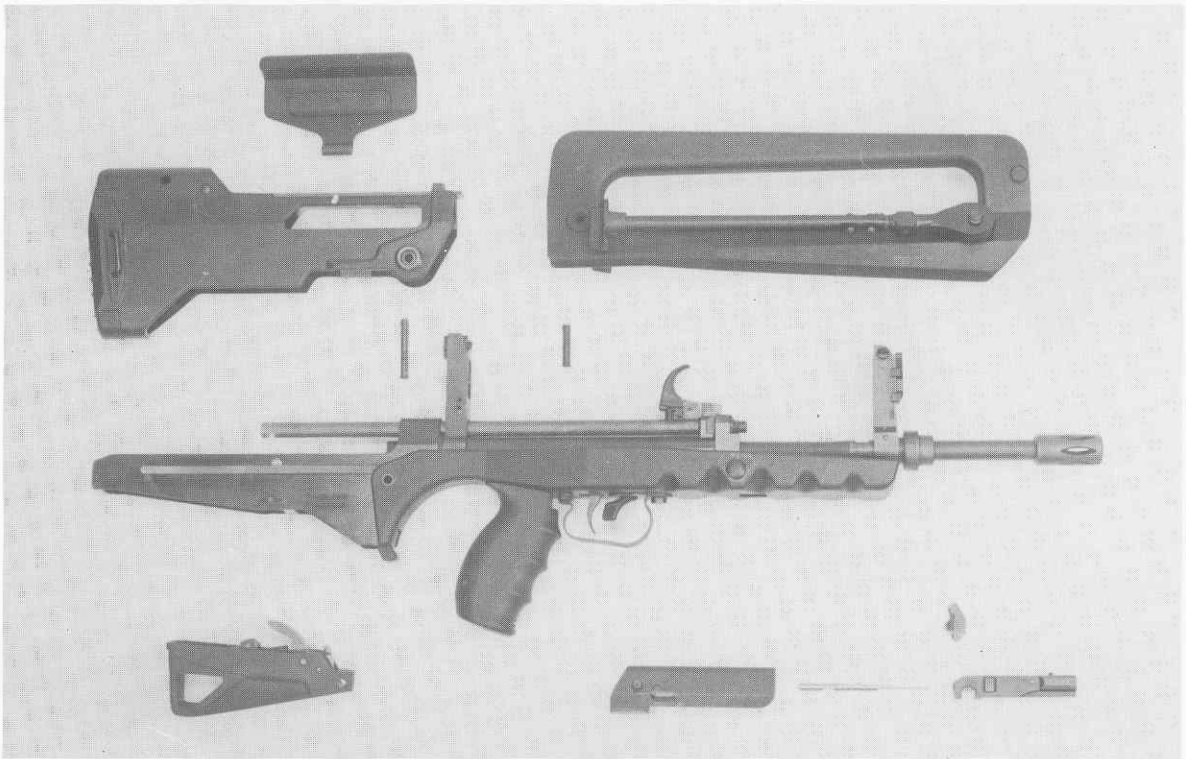

2-1-1 — Rifle body unit (stock — breech casing — cocking mechanism — barrel)

The splined chamber barrel is fixed to the light alloy breech casing. This barrel and casing assembly forms the basic structure of the weapon, on to which are fixed 4 non-removable assemblies :

- 1 — The sub-assembly comprising outer tube and sighting apertures
- 2 — The foresight support
- 3 — The cocking mechanism
- 4 — The stock

and 5 removable assemblies :

- 1 — The mobile assembly in the T-slideway.
- 2 — The mechanism unit fitted by pinning to the rear of the magazine casing.
- 3 — The stock fitted by pinning to the front of the magazine casing.

4 – The magazine fitted by means of a hook fixed to the front of the magazine casing.

5 – The protective handle which is fixed to the outer tube sub-assembly by centring on the main spring rod fixture nut and by pinning to the ringsight unit.

2-1-1-1 – The outer tube sub-assembly

This sub-assembly is screwed on to the barrel and incorporates :

– The cocking system fitted by fastening to the main spring guide rod.

– The stock fitted, by centring on the stock spacer on the forward hoop of the outer tube.

– The ringsight unit, fitted by means of the ringsight unit screw, spring, pointer and elevation screw ; these 4 parts are provided for adjusting the line of sight elevation.



2-1-1-2 – The cocking mechanism

The mechanism comprises :

– The cocking lever which closes the mobile assembly on to the cocking lever stop.

– The spring tube, sealed and lubricated for life, which contains the main spring and ensures the connection between the cocking lever and the mobile assembly.

2-1-1-3 – The stock

The stock is fitted on to the breech casing by crimping a cylindrical liner and on to the outer tube sub-assembly by centring the stock spacer on the forward hoop of the outer tube.

The stock incorporates :

– The selector plate for trigger guard adjustment.

– The trigger and firing selector : single shot, safety.

– The trigger guard arch.

– The pistol grip which is hollow and closed at the bottom by a hinged cover, so that it can be used to contain cleaning (oiler) or spare parts.

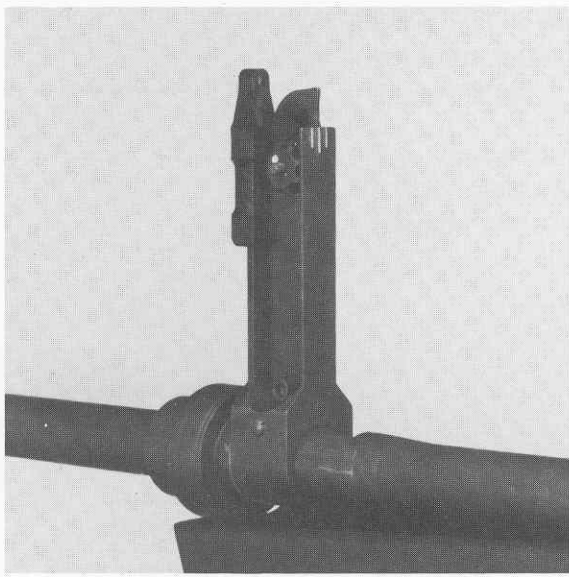

2-1-1-4 – The foresight support

This part is fitted to the barrel by pinning and incorporates:

- The foresight consisting of a spring blade which allows line of sight direction adjustment.
- The retractable slide with luminescent spot for night firing.

2-1-2 – The bolt

The bolt comprises :

- The added mass which enables hooking of the bolt to the spring tube through a sliding pin fixed to the latter part.
- The breech bolt with central ejector, designed for ejection to the right or to the left by reversing the extractor and the plug after dismantling the bolt.
- The firing pin.
- The delayed blow-back lever.

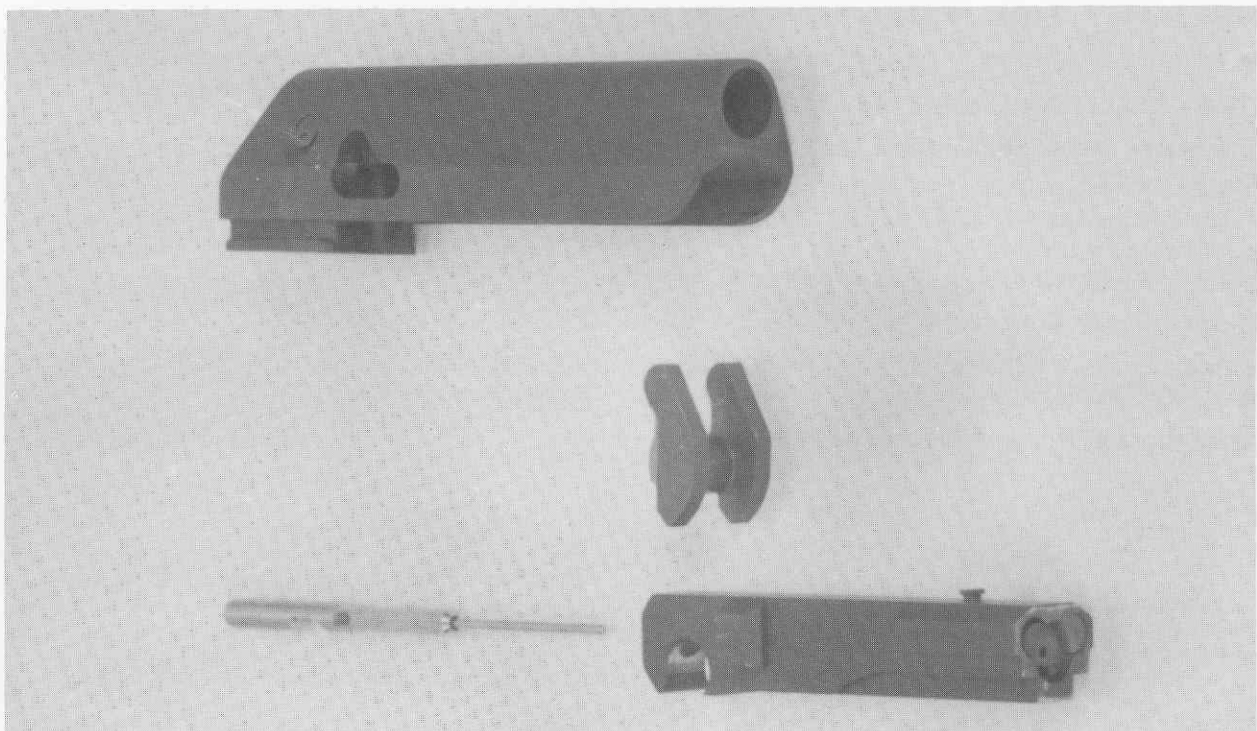

2-1-3 – The mechanism unit

This unit is made up of a plastic shell containing the trigger and hammer mechanisms

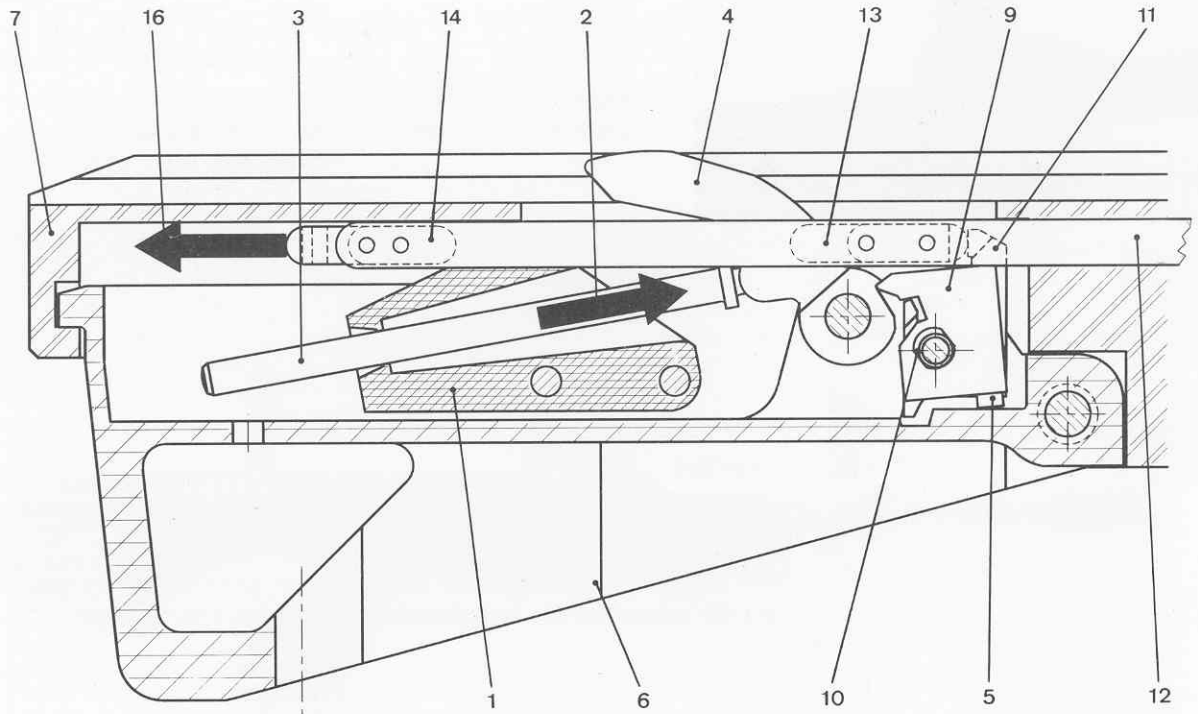

Diagram 1

2-1-4 – The stock and cheek rest

The plastic stock has a rubber recoil mechanism

The cheek rest is fitted to the right or left of the stock depending on which side has been selected by the firer for ejection.

2-1-5 – The protective handle

The plastic part protects the sighting parts :

- Against accidental dropping of the weapon or shocks, and offers an effective grasp for transport.

It incorporates the bipod articulations.

2-1-6 – The magazine

The weapon takes a 25 bullet cartridges magazine

The 25 cartridges magazine has a steel frame, a shoe-plate, a follower spring and a plastic follower plate.

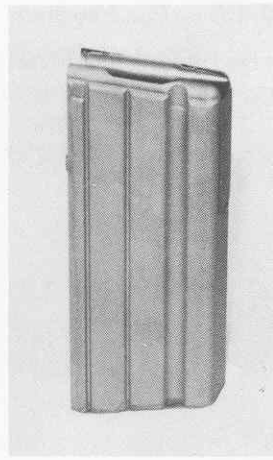

2-1-7 – The universal sling

The sling is made of synthetic material, and comprises a long belt with a hooking device at one end and a short belt fitted with a mobile slide. The width of the sling may be adapted to the morphology of the user, and allows the weapon to be carried in several different ways : over the shoulder, on the back, on the stomach.

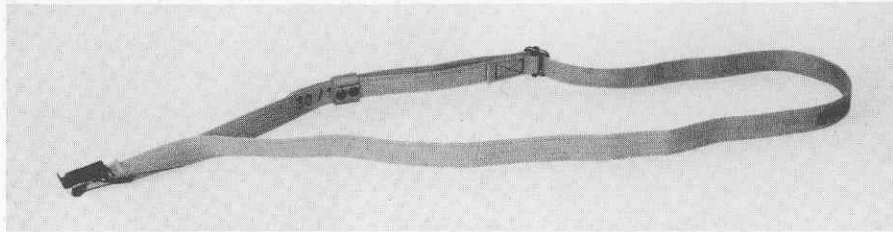

2-1-8 – The bipod

The bipod comprises two independent branches with plastic base, which are attached to the articulations fitted to the protective handle.

It has two positions :

- transport
- utilisation



2-1-9 — The bayonet

The bayonet is fitted to the weapon by centring and is locked in position on the flame protector sleeve. It has a plastic sheath.

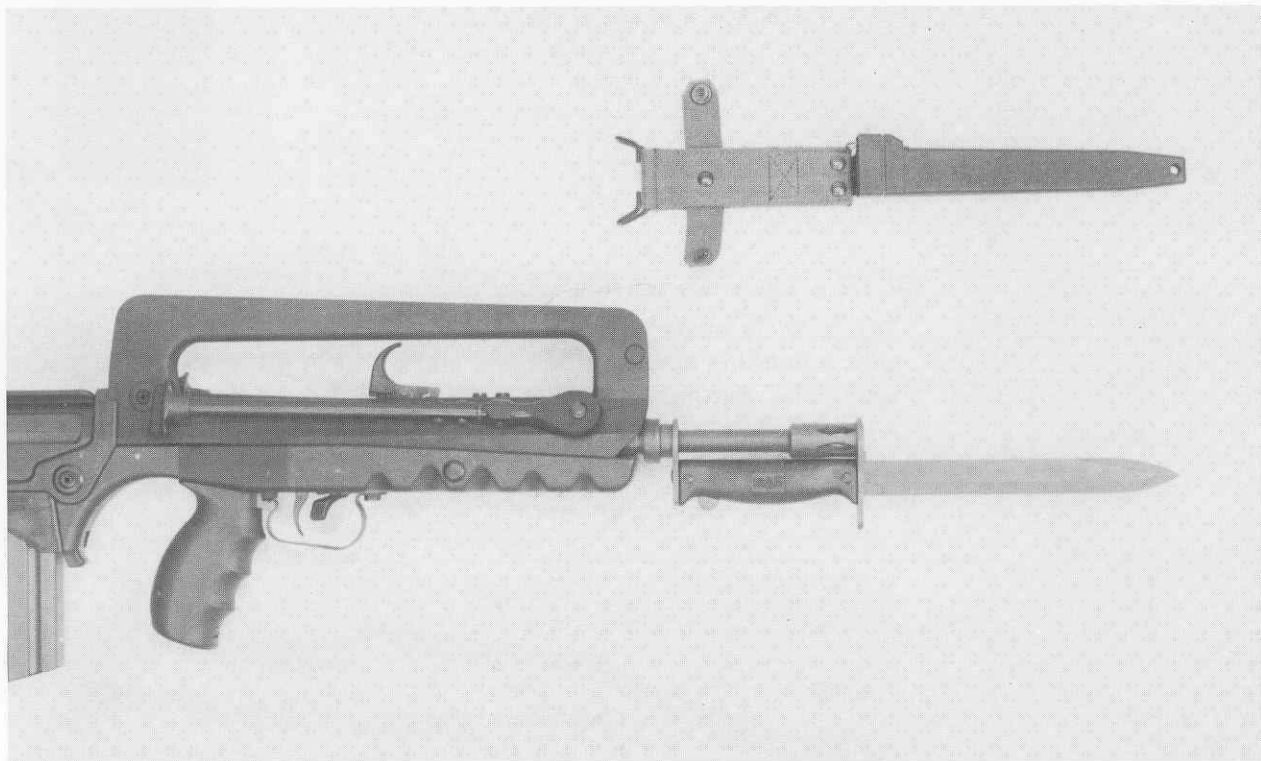

2-2 – OPERATION

2-2-1 – Operating principle

The action of gas on the breech head through the case causes the backward movement of the breech. Opening is delayed by the inertia amplifying system

2-2-2 – Closing and loading mechanism

Backward movement (diagrams 2 and 3)

– The amplifying lever, under the breech bolt thrust and by the action of the two lower arms on the receiver bearing surface, pushes back the added mass with a speed increased by the amplifying ratio.

– The angular stroke of the lever is 45° and during this rotation the following operations are effected :

– Firing pin withdrawal.

– Extraction by means of the extractor fitted to the right or the left according to the firer's preference.

– After complete rotation of the lever, the backward movement of the bolt is effected for each of these parts at the same speed and the compression of the main spring takes place throughout the backward movement.

– A new cartridge is presented when the breech has moved back beyond the magazine casing.

– At the end of the backward stroke, the bolt's surplus energy is absorbed by the shock absorber, which it compresses over a maximum stroke of 25 mm.

Diagram 2

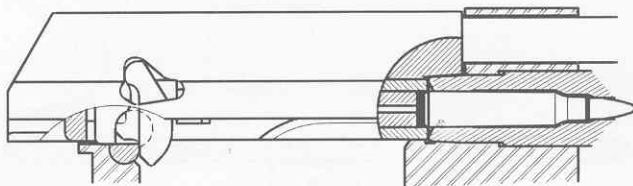
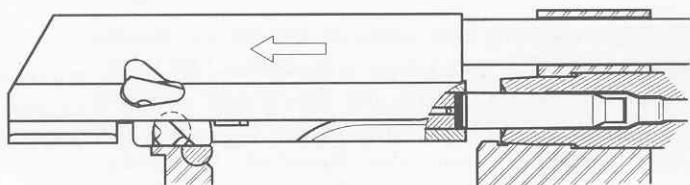

Diagram 3



Forward movement :

The movement is actuated by the main spring trigger and includes :

– Introduction of a new cartridge by breech thrust on to the base of the cartridge presented during the backward movement,

– Closure of the breech which causes the extractor claw to engage the case groove and compression of the ejector spring,

– Complete closure of the bolt, ensured by the backward movement of the added mass, which brings the amplifying lever back to the vertical position, by pushing the top of its upper arms.

Closure is considered "complete" when the cocking lever has moved beyond the cocking lever stop.

2-2-3 – Trigger and firing mechanism

The trigger mechanism is of the so-called "escaping cam" type. (See diagram 1 page 10).

2-2-3-1 – Firing selectors

– The weapon has one selector located at trigger level.

– The semi automatic firing method may be chosen:

– Firing selector on position "1":1 shot.

2-2-3-2 – Single shot operating mode

By pulling the trigger (17), the connecting rod (12) causes rotation of the sear drive (11) and the driven sear (9) which frees the hammer (4); see diagram 4.

The hammer, under the action of the hammer spring (2), pivots violently around its axis and strikes the firing pin which causes departure of the shot.

Cocking of the hammer is effected during the backward movement of the bolt

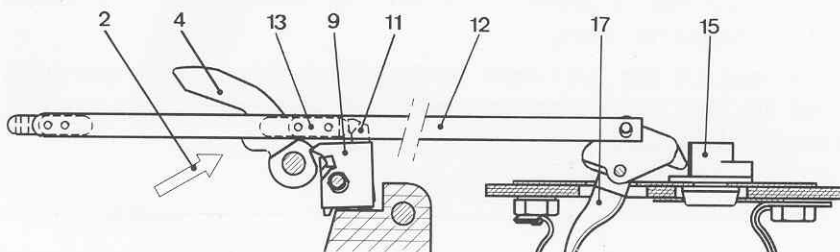

Diagram 4

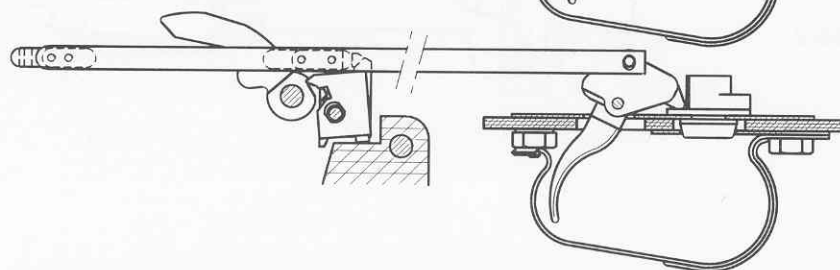

Diagram 5

At this moment, the hammer hooks on to the driven sear (9) and firing is stopped. The interruption of finger action on the trigger releases the sear drive (11) from the driven sear (9), the latter ensuring that the hammer is always hooked in position ready to fire (diagram 5).

2-2-5 – Weapon safety

– All the weapon's safety functions are ensured by the delayed blow back lever (diagram 6).

1 – The backward movement of the firing pin : if the bolt is not completely closed and the hammer drops, it sends the firing pin against the delayed blow back lever and firing of the cartridge in the chamber cannot take place due to the lack of a projecting boss.

– The backward position of the firing pin produced by rotation of the delayed blow back lever avoids accidents due to the inertia movements of the firing pin, when closing.

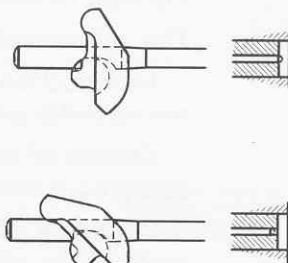

Diagram 6

3-1 — Preliminary operations and checks

See paragraph 1-6 : Safety instructions concerning the equipment before firing. In particular, make sure :

- for ball cartridge firing, that the cheek rest is on the opposite side to ejection.
- For optimum operational regularity, even under prolonged firing conditions, that the quantity of lubricant on the moving parts and trigger mechanism does not exceed the film value required for adequate protection from corrosion.

N.B. : Under special conditions of sand or dust storms in desert areas, the rifle must be dry before firing.

3-2 — Operating methods and checks

3-2-1 — Ball cartridge firing

3-2-1-1 — Use of magazine

- Loading a magazine :

Two cases :

1 — Cartridges supplied in bulk.

Insert the cartridges by pressing them one by one into the magazine, making sure to place the cartridge base at the end with the two small rear ribs.

2 — Cartridges supplied on loading clip

Place the loader supplied with cartridges on the magazine. Fit the loading clip to the loader.

Insert the series of cartridges by pressing the row of cartridges, with the thumb.

- Unloading a magazine

Expel the first cartridge towards the front by pressing the base of the cartridge using the base of another cartridge.

3-2-1-2 — Inserting the magazine

- Place the weapon in the safety position (S mark on the firing selector).
- Insert the magazine at an angle in order to engage the rear part of the lips of the magazine casing first of all, and tip the lower part of the magazine towards the front thereby pushing it into the casing until it clicks into place.

3-2-1-3 — Removing the magazine

- Place the weapon in the safety position (S mark).
- Press the magazine hook and pull the magazine downwards by tilting it slightly towards the rear of the weapon.
- If applicable, remove any cartridge that may remain in the chamber by manual cocking.

3-2-1-4 – Manual cocking

- Place the weapon in the safety position (S mark).
- Grasp the cocking lever with one or two fingers, pull it until the bolt comes up against the shock absorber and let it come back to the front **without accompanying it.**
- If the mechanism does not complete its forward travel (incomplete closure) due to an excessive amount of impurities (mud, sand, snow, etc.) slight forward pressure has to be exerted on the cocking lever heel in order to complete closure. If closure is still difficult, check that there are no foreign bodies in the barrel or breech.
- Depending on the position of the firer, the rifle is cocked by the right hand or the left hand.
- Since the rifle does not have a breech stop, repeat the same operation again, after each insertion of a magazine.

3-2-1-5 – Uncocking

- Remove the magazine. See 3-2-1-3.
- Cock the weapon in order to extract and eject any cartridge which might still be in the chamber.
- Pull the trigger, **taking care to point the rifle in a safe direction.**

3-2-1-6 – Aiming for ball cartridge firing

The aiming device offers three possibilities (2 for daylight firing and one for night firing).

3-2-1-6-1

- Day firing
 - With normal light, keep the two flaps of the ringsight closed, the eye-piece diameter is minimum and gives maximum precision.
 - In bad light, flip down the front flap, the diameter of the eye-piece is greater.

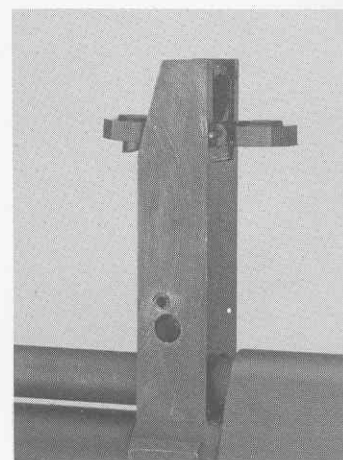
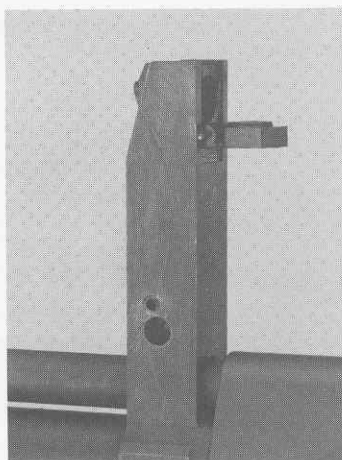

3-2-1-6-2

- Night firing
 - Flip down the two ringsight slide flaps and lift up the slide located on the front face of the front sight support. For ball cartridge firing, it is necessary to align the target, the green luminescent spot (materialising the support)

3-2-1-7 – Firing

Semi-automatic firing

- Firing selector on position 1.
- Pull the trigger, a single shot is fired. Release the trigger. The following cartridges are fired in the same way until the magazine is empty.
- For precision firing, the finger pressure control on the trigger is facilitated by a small boss.

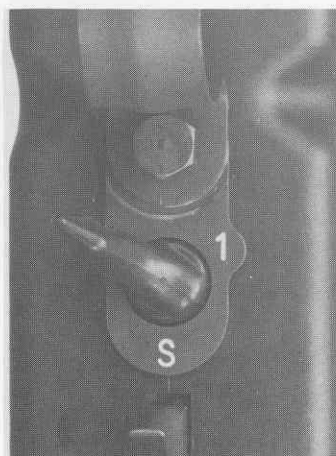

3-2-2 – Using the bipod

Deployment of the bipod

- Take one leg of the bipod and pull it towards the rear of the rifle *until it can swivel freely* around its joint.
- Swivel the leg forwards until it clicks into the notch of the required position.
- Repeat this operation for the second leg.

Folding away of bipod

- Give a sharp knock on each leg, which then automatically returns to the transport position.

3-2-3 – Use of the sling

- 1 – The hooking device of the long belt is placed on its hooking point located on the bipod drum, by successive half-turns.



- 2 – Insert the long belt in the metal buckle with beaks of the small belt (beaks upside down).

- 3 – Fold over the long belt after threading it through the stock loop and insert in the quick tightening device then through the loop.



Use of "shoulder slung weapons"

- Hook on the metal buckle by means of its beaks to the hooking ring as indicated in the photograph.



"Combat" use

- Unhook the metal buckle with beak from the hooking ring.
- The metal buckle then slides along the long belt.
- Place the weapon slung across the chest.
- From this position it is possible to take aim quickly.

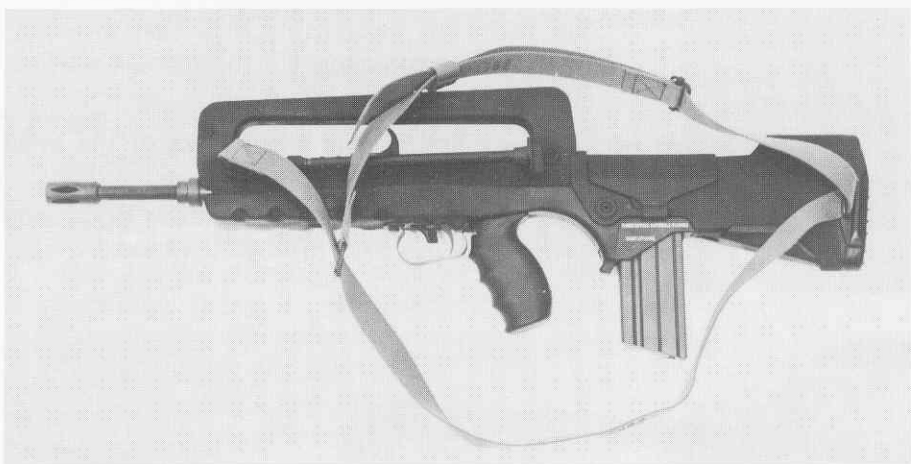

4 — USE IN SPECIAL CONDITIONS

— cf. paragraph 1-5 operating limits (page 5)

4-1 — Very low temperatures

Use of the trigger guard arch

— Pull on the part of the arch located on a level with the pistol grip so as to release it from its normal operating position.

— Turn through 180° to set it for use at very low temperatures

Use a lubricant compatible with the operating temperature. If not, clean and lubricate with paraffine oil only.

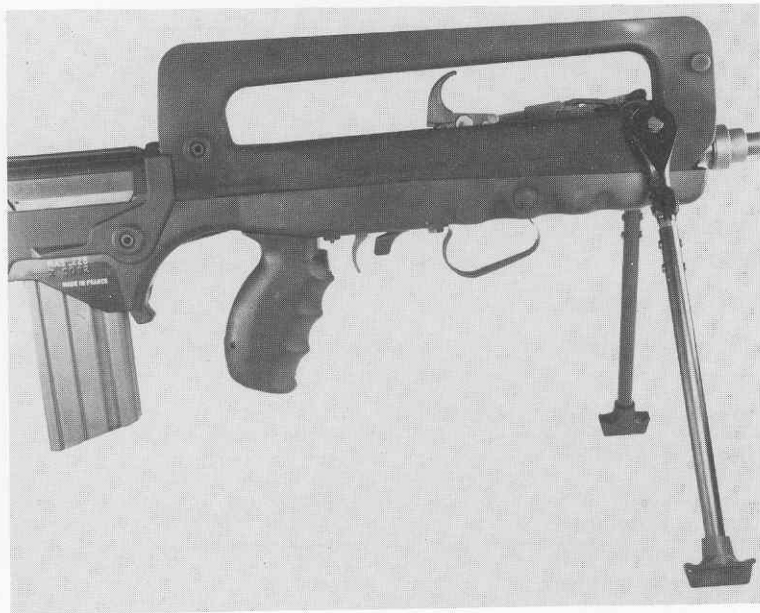

4-2 — Precautions to be taken during movements when water is likely to enter the barrel (rain, weapon dropped into water, etc.)

— Take the precautions mentioned under section 1-6-2, second paragraph.

4-3 — Sand and dust

Reduce lubrication to the minimum.

4-4 — Bullet firing at night

See para. 3-2-1-6.

5 — JAMMING AND TROUBLE

5-1 — Jamming

Possible jamming and trouble generally fall into one of the following three categories :

- 1 — Trouble resulting from excessive fouling of the weapon due to negligence by the user or his lack of knowledge of the weapon.
- 2 — Trouble caused by accidental mechanical failure of the weapon.
- 3 — Trouble caused by using the weapon in unfavourable conditions (snow, sand, mud...).

Jamming or interruption of firing, unless caused by an empty magazine or failure of a part, is generally quickly eliminated without looking for the cause of the trouble.

— If there is incomplete closure, press on the base of the cocking lever so as to make sure that the lever closes on to the cocking lever stop, then resume firing. If slight pressure is insufficient to close the cocking lever, ensure that there is no foreign body fouling the barrel or firing mechanism.

— If there is insufficient recoil, cock to eject the case of the fired cartridge and insert another cartridge, then resume firing.

— In the case of any other firing trouble :

- Keep the weapon in firing position.
- Remove the magazine.
- Cock twice.
- Remove the case remaining inside the weapon (if applicable).
- Insert magazine — cock, then resume firing.

Should the trouble occur again : remove the magazine, replace it by another, then resume firing. If the trouble persists, consult the gunsmith to determine what is wrong.

NB : if the shot does not take place after firing, wait at least 10 seconds before opening the breech so as to avoid the consequences of possible delayed firing.

Possible troubles	Causes	Remedies
No percussion	Incomplete closure Firing pin broken	Cock and make sure of closure before firing Change firing pin
No extraction	Extractor deteriorated Chamber fouled	Change extractor Clean weapon and clean chamber (rifling)
Resistance felt when inserting magazine	Weapon fouled Magazine warped	Clean weapon Change magazine
Incorrect position of cartridge	Magazine warped Follower plate warped	Change magazine
Cartridge case not ejected	Ejector spring too weak Extractor spring too weak	Change ejector-spring assembly Change extractor-spring assembly
Delayed firing	Defective cartridge	Check to ensure bullet is not still in barrel

6 — MAINTENANCE

6-1 — Dismantling for maintenance and reassembly.

6-1-1 — Remove the stock

- If the strap is tight, slacken it as would normally be the case for carrying the weapon over the shoulder.
- Expel the stock assembly stud, and place it in the tubular casing for fixing the stock to the breech casing.
- Pull the stock backwards.
- In order to dismantle the cheek rest, push the top of this part so that by elastic deformation it can be removed from the stock.

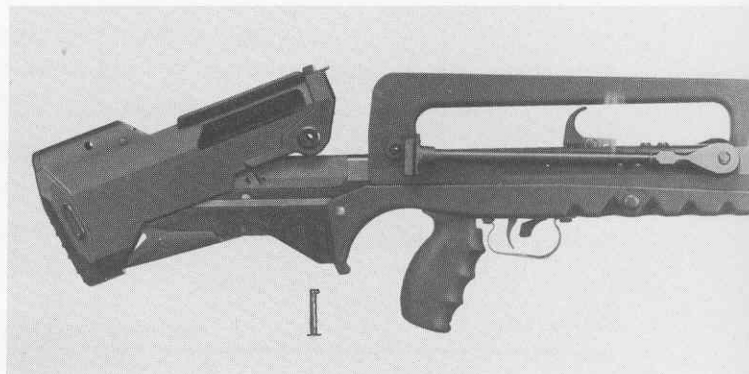

6-1-2 — Remove the protective handle.

- Expel the assembly stud of the protective handle and place it in the tubular casing fitted to the ringsight support.
- Push the protective handle towards the foresight, removing it from the sighting line by pulling it upwards.



6-1-3 — Remove the mechanism unit

- Push the mechanism unit assembly stud with the tip of a bullet or one of the two stock studs or protective handle studs and pull it so as to bring it into contact with the breech casing safety catch.
- Remove the mechanism unit by rotating it round the rear support of the breech case.

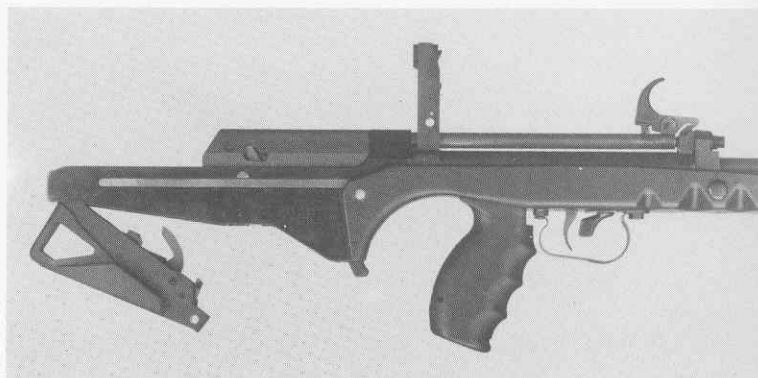

6-1-4 – Remove the mobile assembly

- Pull back the mobile assembly until the cocking lever makes contact with the rear face of the cocking lever stop.
- Free the mobile assembly from the spring tube by pushing the assembly stud as under para. 6-1-3.
- Pull the mobile assembly backwards, allowing it to slide freely in the T groove of the breech casing.

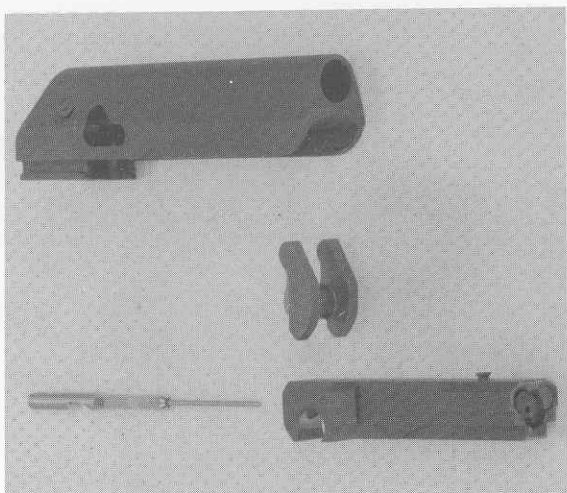

6-1-5 – Disassembly of the bolt

- Separate the mobile breech assembly, the inertia amplifying lever and the firing pin from the added mass by making it slide along the bottom of the latter part until the lever is in the vertical position. In this position the slide on the head of the breech is freed from the corresponding part of the added mass, and the two parts can be separated by pulling on them.

Dismantle the amplifying lever by making it turn around its axis until its upper wings are in line with the breech and remove it from its housing in this position.

Pull the firing pin backwards.

6-1-6 – Dismantling the removable head

- Using the base of a case or the head of one of the stock assembly studs or protective handle studs, raise the support finger of the removable head.
- Engage the base of the case or the head of one of the stock assembly studs or protective handle studs under the extractor claw and pull the removable head.
- After dismantling in this way, there are 6 parts or assemblies :
 - The breech
 - The removable head
 - The support finger
 - The ejector, its spring and its inside rod
 - The extractor and its spring
 - The plug.

In order to reverse the ejection, simply exchange the extractor and its spring with the plug.

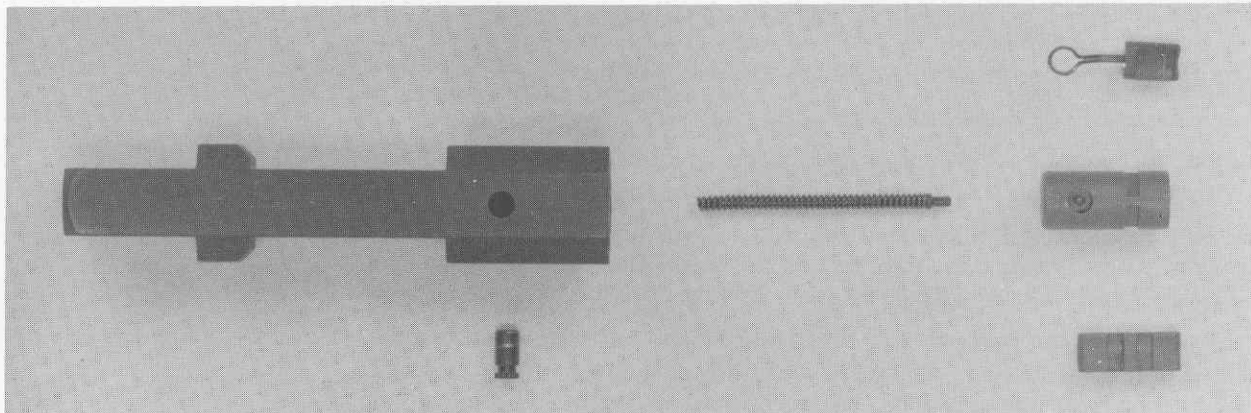

6-1-7 – Dismantling the bipod

To dismantle the bipod proceed in the same way as for mounting it (section 3-2-2), but continue to rotate the arms 120° beyond their normal position in use and in that position remove them laterally from their articulations.

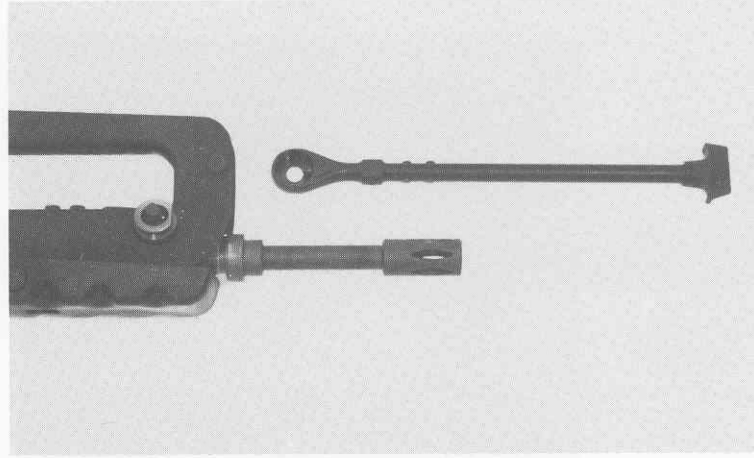
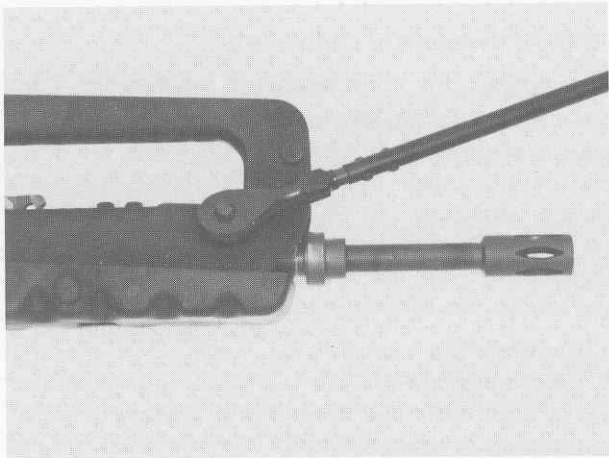

6-1-8 – Reassembly

Reassembly is carried out in the reverse order of dismantling, although the following precautions must be taken :

– Reassembly of the removable head :

Before reassembling the ejector make sure that *the inside rod is exactly in place* (photo page 23).

– Use the spring ejector assembly to centre the removable head so as to be able to fit the support finger without any difficulty.

– Push the removing head with the firing pin.

– Fit the support finger, paying attention to the direction of assembly : the groove in which the base of the case is engaged (section 6-1-6) must be outside the breech after assembly.

– Reassembly of the mobile assembly :

First of all, assemble the firing pin and align the rear notch of the amplifying lever passage with the breech bore before reassembling the lever.

Before reassembling the added mass make sure that the two supporting parts of the amplifying lever on the added mass are *opposite the heel of the mobile breech*.

Before assembling the mobile assembly on the breech casing make sure that the slideway located on top of the breech is effectively engaged in the corresponding part of the added mass.

– Reassembly of the mobile assembly on the breech casing :

Hold the mobile assembly in the *open position* and slide it freely, without forcing, in the slideway of the breech casing.

– Reassembly of the mechanism unit : before reassembling the mechanism unit make sure that the hammer is hooked on to the driven sear and that the connecting rod is in the rear position.

Engage the rear part of the mechanism unit into the corresponding housing of the breech casing by inclining it slightly (photo page 22), pivot it around this hooking point and pin it.

- Reassembly of the protective handle :
- Reassembly of the stock :

Make sure that the cheek-rest is mounted on the *side opposite ejection*.

6-1-9 – Reversing of ejection

- Remove the support finger as indicated in section 6-1-6 and pull the removable head as far as necessary to be able to pull out the extractor and the plug without completely dismantling the removable head.
- Reverse the two parts.
- Push the removable head back place by means of the firing pin and replace the support finger.

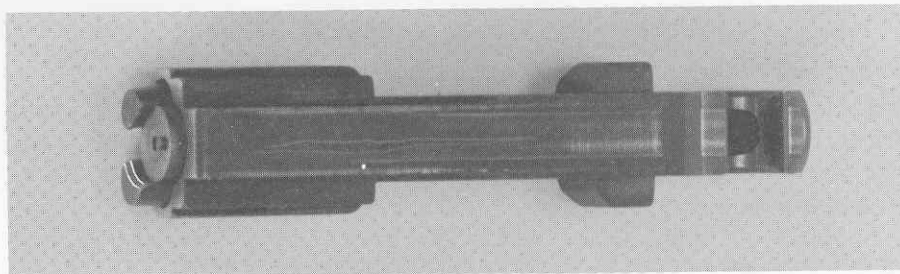
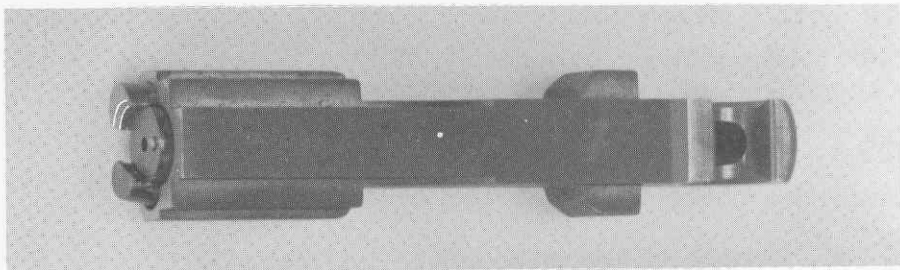

6-2 – Maintenance

6-2-1 – Ingredients

Use Break-Free CLP or ARDROX 397/2 – paraffin oil only under exceptional circumstances.

Attention :

- The use of paraffine oil facilitates cleaning of very fouled components but in order to avoid oxidation, *carefully clean the parts before oiling them.*
- Do not use chlorine solvents without the manufacturer's advice.

6-2-2 – Cleaning

The weapon must be cleaned as often as necessary, and obligatorily after each use, as soon as circumstances permit.

Cleaning must be limited to the removal of dust, moisture, impurities and surface rust. Cleaning must never be taken to extremes, where wear or deformation of the parts could arise.

N.B. : The use of abrasive substances (emery cloth, glass paper) or metal objects (knife blade or screwdriver) is strictly forbidden.

6-2-2-1 – Cleaning the barrel and chamber

The barrel is cleaned with a cleaning rod used with a square cloth of dimensions (6 x 6 cm of fine cloth) such that it forces slightly in the barrel. The cleaning cloth must be removed from the barrel after each return stroke. Introduce the cleaning rod by the barrel mouth piece so that the patch does not catch in the ring grooves.

After a few strokes effected with a dry, clean cloth, the internal surface of the barrel must be smooth and shiny. Otherwise, continue cleaning with an oil-soaked cloth.

The chamber must be cleaned with a metal brush; use an oil-soaked cloth to remove any matter fouling the chamber.

6-2-2-2 – Cleaning of other metal parts

Other parts must be cleaned with a dry, clean cloth or with paraffin oil if the parts are very dirty.

If rust patches show up, soak them in oil for a moment, then rub with an oil-soaked cloth.

6-2-2-3 – Cleaning of plastic parts

Clean with a moist clean cloth.

6-2-2-4 – Cleaning the mechanism unit

If metal debris or non-burnt products have entered the mechanism unit, clean the trigger mechanism with a fine brush.

6-2-3 – Checking

Each cleaning should be an occasion for checking the condition of the various parts of the weapon, and to show up incipient cracks, unusual wear and other deformations as well as breakage : in particular, the firing pin and the amplifying lever.

6-2-4 – Protection

Once the weapon is cleaned and its condition checked, it is necessary, before reassembly, to give it a protection against rust.

All the metal parts should be lightly oiled after cleaning. The barrel is protected by giving one backward and one forward stroke with an oil-soaked cloth which should be clean.

6-3 – Adjusting the line of sight

See 6-1 for dismantling of the protective handle.

6-3-1 – Adjustment for elevation

– The line of sight is adjusted for elevation by moving the ringsight unit as follows. Lower the adjustment wheel index and then compress the ringsight spring by means of the screw. To facilitate this operation, a cartridge case can be removed to compress the spring.

– If the rifle fires high : tighten the bolt and the ringsight is lowered.

– If the rifle fires low : unscrew the bolt and the ringsight rises.

– Shift value : one rotation of a bolt notch leads to an average point variation of about 6 cm at a distance of 200 mètres (0.30 m).

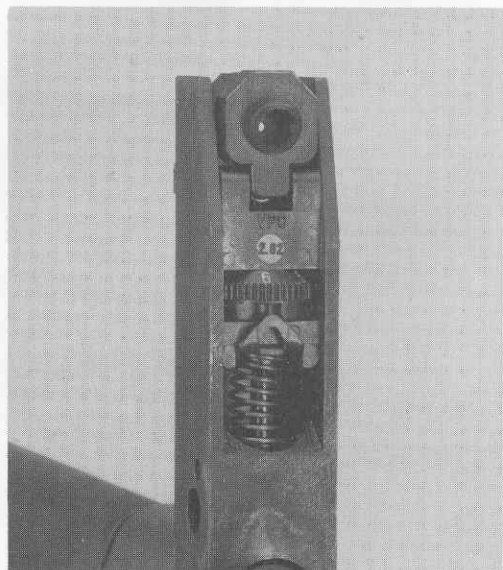

6-3-2 – Adjustment for direction

- Direction is adjusted by compressing or releasing a spring blade by means of a serrated nut.
- If firing is to the left : screw off.
- If firing is to the right : screw on.
- Value of the shift : the passage from one notch to another causes a variation in the mean centre point of about 6 cm at 200 m (0.30 m).

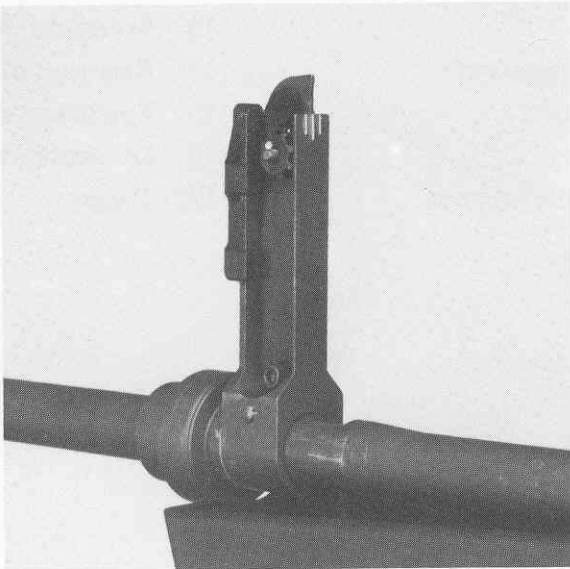

7 — PARTS LIST

Description of the parts itemised on the various diagrams

1	Hammer stop	10	Driven sear notch
2	Percussion spring	11	Driven sear drive
3	Percussion rod	12	Connecting rod
4	Hammer	13	Forward stud of connecting rod
5	Sear spring guide rod	14	Rear stud of connecting rod
6	Mechanism unit	15	Fire selector
7	Breech casing	16	Connecting rod return spring
8	Inertia amplifying lever	17	Trigger
9	Driven sear		

8 - TABLE OF COMPINED UNIT COMPONENTS

PART NAME	Qty
MAS . 223 REM semi-automatic rifle	1
ACCESSORIES	
Magazine	2
Bayonet with sheath	1
Sling	1
Removable rod	1
Cleaning rod	1
Chamber cleaning brush	1
Brass cleaning brush	1
Nylon cleaning brush	1
Oil can	1
Synthetic cloth bag for accessories	1
Synthetic cloth magazine holder	1
Technical guidance leaflet	1
SPARE PARTS	
Support finger	1
Complete ejector	1
Extractor with spring	1
Cover	1

mas

GIAT



3, Rue Javelin Pagnon

42007 St-Etienne Cedex BP 505

France

tél. 77 74 91 88